

DUAL ZONE OUTDOOR PIR

MX-12FAM

up to 12m x 180° + Anti-Masking



Dual zone detection system reduces false alarms for reliable outdoor protection

DUAL ZONE DETECTION SYSTEM

Horizontal and downward zones require simultaneous detection preventing nuisance alarms from small animals and passing vehicles.

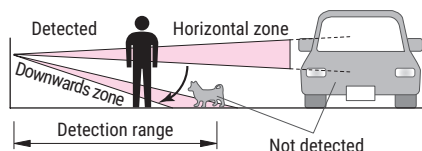

180 DEGREE WIDE ANGLE COVERAGE

Up to 180° of complete coverage, with independent 2m - 12m adjustable protection distance for left and right sides for maximum installation versatility.

DUAL ALARM SIGNAL OUTPUTS

Choose between:

- individual alarm outputs per 90 degree left and right side or
- a combined 180 degree output + external output for triggering CCTV or ancillary devices.

ANTI-MASKING

Protected by sophisticated Anti-Masking technology with near-lens awareness, designed to initiate an alarm if the device is compromised.

BACK TAMPER

Equipped with both front and back tampers to detect interference or attempted theft of the sensor any time of the day or night.

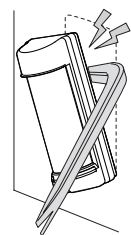

IMPROVED AREA MASKS

Durable area masks stored within the device allow the coverage pattern to be customised to specific site requirements.

PULSE COUNT & SENSITIVITY ADJUSTMENT

The pulse count can be changed between 1 & 3, and the sensitivity adjusted between 60 & 120% to maintain operational stability in difficult conditions.

DUAL ZONE OUTDOOR PIR

COVERAGE PATTERN

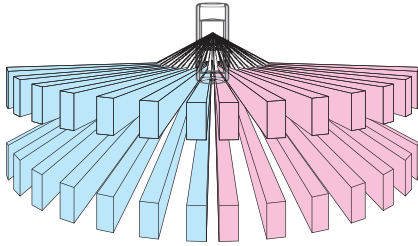

DETECTION AREA

[Wide angle detection]

[TOP VIEW]

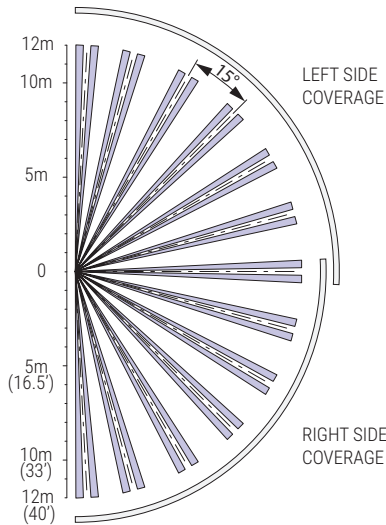

[SIDE VIEW]

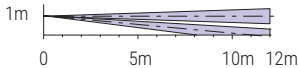

TERMINAL CONFIGURATION

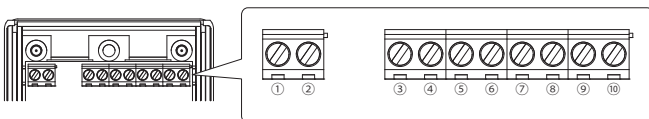

①	②	③	④	⑤	⑥	⑦	⑧	⑨	⑩
POWER		ALARM(1)		ALARM(2)		TROUBLE		TAMPER	
		ALARM RIGHT + LEFT		EXTERNAL OUTPUT					
		ALARM RIGHT		ALARM LEFT					

Mode setting "B" ON
Mode setting "B" OFF

POWER : 9 to 28V DC (non-polarity) Current consumption 30mA Max.
 ALARM OUTPUT (1) : 30V (AC/DC) 0.2A Max. (Resistive load), N.O./N.C. selectable
 ALARM OUTPUT (2) : 30V (AC/DC) 0.2A Max. (Resistive load), N.O./N.C. selectable
 (For EXTERNAL OUTPUT : N.O. only)
 TROUBLE OUTPUT : 30V (AC/DC) 0.2A Max. (Resistive load), N.C.
 TAMPER OUTPUT : 30V (AC/DC) 0.1A Max. (Resistive load), N.C.

OPTIONAL

- Pole attachment <BP-32>

SPECIFICATIONS

Model	MX-12FAM
Detection system	Passive infrared
Coverage	horizontal detection Angle : 180°, Detection distance : 12m (40') Horizontal zone : 14 zones Downward zone : 14 zones
Coverage adjustment	Detection distance : 2 to 12m (10' to 40') [10 ranges] (by adjusting vertical angle of downward curtain) Possible left and right individual adjustment
Supply voltage	9 to 28V DC (non-polarity)
Current consumption	30mA Max.
Alarm output (1)	RIGHT+LEFT Dry contact relay output N.O./N.C. selectable • Contact capacity : 30V (AC/DC) 0.2A Max. (Resistive load) • Contact operation : Detection time (+2sec.)
Alarm output (2)	LEFT Dry contact relay output N.O./N.C. selectable • Contact capacity : 30V (AC/DC) 0.2A Max. (Resistive load) • Contact operation : Detection time (+2sec.)
	EXTERNAL OUTPUT Dry contact relay output N.O. • Contact capacity : 30V (AC/DC) 0.2A Max. (Resistive load) • Contact operation : Detection time (+30sec. latch time)
Trouble output	Dry contact relay output N.C. • Contact capacity : 30V (AC/DC) 0.2A Max. (Resistive load) (Masking detection / Low supply voltage / Self diagnosis error)
Tamper output	Dry contact relay output N.C. • Contact capacity : 30V (AC/DC) 0.1A Max. (Resistive load) (Cover tamper / When back tamper is detected)
Operation LED	Red LED • Warm-up (Blinks) • Alarm detection (Lights approx. 2sec only Walk test) • Masking detection (Blinks rapidly) • Low supply voltage (Blinks slowly) • Self diagnosis error (Lights continuously)
Pulse count	1 / 3 times (selectable with DIP switch)
Sensitivity adjustment	60% / 80% / 100% / 120% (selectable with DIP switch, left and right set individually)
Functions	Anti-Masking, Back Tamper, Trouble alarm, Low voltage monitoring
Connection	Terminals
Ambient temperature	-25°C to +60°C (-13°F to +140°F)
Mounting position	Indoor / Outdoor
Ingress protection	IP55 (Wall mount)
Weight	350g (12.4oz)
Appearance	Body : resin (white) / Lens : resin (white)
Optional	Pole attachment : BP-32

* Specifications and design are subject to change without prior notice.

EXTERNAL DIMENSIONS

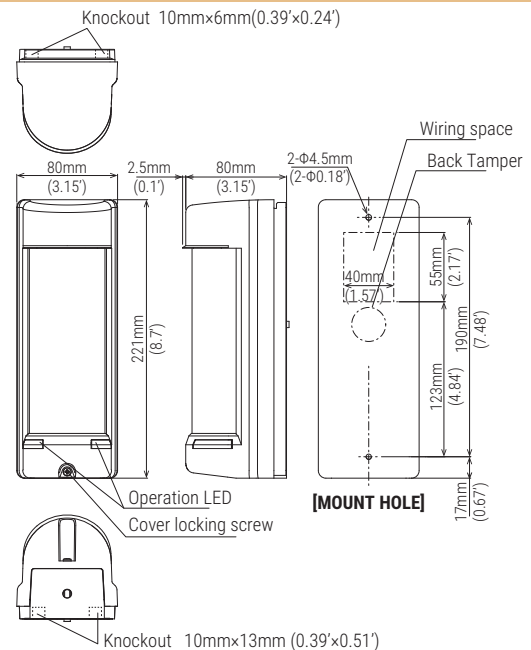

In Japan

Takenaka Engineering Co., Ltd.
 83-1, Gojo-Dori, Sotokan Nishi-iru, Higashino,
 Yamashina-ku, Kyoto 607-8156, Japan
 Tel : 81-75-501-6651
 Fax : 81-75-593-3816
<https://www.takex-eng.co.jp/>

In the U.S.

Takex America Inc.
 151, San Zeno WAY
 Sunnyvale, CA 94086, USA
 Tel : 408-747-0100
 Fax : 408-734-1100
<https://www.takex.com>

In Australia

Takex America Inc.
 4/15 Howleys Road, Notting Hill,
 VIC, 3168
 Tel : +61 (03) 9544-2477
 Fax : +61 (03) 9543-2342
<https://www.takex.com>

In the U.K.

Takex Europe Ltd.
 Aviary Court, Wade Road,
 Basingstoke, Hampshire, RG24 8PE, U.K.
 Tel : (+44) 01256-475555
 Fax : (+44) 01256-466268
<https://www.takex.com>

Please note:

This sensor is designed to detect intrusion and to initiate an alarm; it is not a burglary or a crime preventing device. TAKEX is not responsible for damage, injury or losses caused by accident, theft, Acts of God (including inductive surge by lightning), abuse, misuse, abnormal usage, faulty installation or improper maintenance.